

# MINNESOTA STATE DEPARTMENT OF PUBLIC SAFETY



## State Fire Marshal Division

444 Cedar Street, Suite 145, St. Paul, Minnesota 55101-5145  
Phone: 651/201-7200 FAX: 651/215-0525 TTY: 651/282/6555  
Internet: <http://www.fire.state.mn.us>

### CHILD CARE (DAY CARE) INFORMATION SHEET

#### SECTION 1 – INTRODUCTION

This fire safety information sheet is based upon the 2007 Minnesota State Fire Code (MSFC), 2007 Minnesota State Building Code (MSBC) and the 2007 International Residential Code (IRC). The requirements outlined in this information sheet apply to Group R-3 (One and Two Family Dwellings) used for licensed child care.

**Family child care home** is a residence, licensed by Department of Human Services under Mn Rules 9502.0315 to 9502.0445, in which no more than 10 children receive care, maintenance and supervision by other than their relatives or legal guardians for less than 24 hours per day.

**Group child care home** is a residence, licensed by Department of Human Services under Mn Rules 9502.0315 to 9502.0445 in which at least 11 but no more than 14 children receive care, maintenance and supervision by other than their relatives or legal guardians for less than 24 hours per day.

These occupancies may be required to meet other code provisions that are not listed in this publication. This information sheet provides an overview of the major code requirements that apply to R-3 Occupancies and does not attempt to cover every situation. References to the applicable code sections are in brackets, [ ].

More information is available from the Minnesota State Fire Marshal Division at (651) 201-7200. E-mail questions to [firecode@state.mn.us](mailto:firecode@state.mn.us) or visit our web page at [www.fire.state.mn.us](http://www.fire.state.mn.us) for the latest information on fire in Minnesota.

#### SECTION 2 — NUMBER, TYPE AND ACCESS TO EXITS

##### 2.1 Number and type of exits

Every room shall have access to at least one exit. This exit usually takes the form of the interior halls, stairs and doors found within the building.

In addition, every room used for sleeping and basements used for child care shall have at least one approved emergency escape (second means of egress) that is separate from the main exit from the space. Any one of the following four options will satisfy the requirement for an emergency escape from a room [MSFC (2007) Section 1026.1]

1. The space is provided with an escape window complying with MSFC (2007) Section 1026.1, as amended or State Fire Marshal Policy INS-04. Because this is the most common type of emergency escape, additional information on escape windows is provided in the next section of this fact sheet.

Alcohol &  
Gambling  
Enforcement

Bureau of  
Criminal  
Apprehension

Capitol Security

Crime Victim  
Services

Driver & Vehicle  
Services

Emergency  
Management /  
Emergency  
Response  
Commission

State Fire  
Marshal /  
Pipeline Safety

State Patrol

Traffic Safety



2. An automatic sprinkler system is protecting the building (NFPA 13D systems are acceptable for one and two family homes).
3. The room has a door leading directly to the exterior of the building.
4. There is a second separate means of escape. The second means of escape may be through an adjacent non-lockable space, independent of and remote from the primary exit. The adjacent non-lockable space must be provided with a code complying exit or egress window. Travel through an attached garage may be permitted as a second separate means of escape if there is no distinct hazard and all of the following conditions are met:
  - Unobstructed access with an aisle at least 36 in. in clear width is provided from the dwelling door to the garage service door.
  - The attached garage is fire-separated from the dwelling as required by the MSFC (2007). See Section 7.1 of this information sheet for occupancy separations.
  - A side-hinged, swinging door to the exterior is provided when the occupant load is 10 or over.

Sliding glass doors may be accepted as qualifying exit doors provided that the doors are maintained operational at all times [MSFC (2007) Section 1008.1.2 Exception 4].

## **2.2 Access to doors and windows**

Exit doors from individual dwelling units may be provided with a night latch, dead bolt or security chain provided that such devices are openable from the inside without the use of a key or tool and mounted at a height not to exceed 48 inches above the finished floor. [MSFC (2007) Section 1008.1.8.3]

All locking devices shall be of an approved type.

## **SECTION 3 — APPROVED ESCAPE WINDOWS**

### **3.1 Types of approved escape windows**

Approved escape windows include the following [MSFC (2007) Section 1026.1]:

- Double hung windows;
- Sliding windows; or,
- Casement windows

**Awning style windows do not meet this requirement.**

### **3.2 Minimum size**

When used as an emergency escape, only a single window in each room need meet the minimum size requirements listed below. The window sash cannot be removed to meet the size requirements and windows must be measured with the window fully opened by the normal window opening mechanism.

**For escape windows installed prior to July 10, 2007:** (State Fire Marshal Policy INS-04)

- A minimum of 20 inches in width
- A minimum of 20 inches in height
- A minimum of 648 square inches (4.5square feet) of clear opening
- A maximum of 48 inches from the floor to the sill opening

*Note: The above is considered the absolute minimum regardless of existing or replacement windows*

**For escape windows installed above or below the level of exit discharge on or after July 10, 2007:**

- A minimum of 20 inches in width
- A minimum of 24 inches in height
- A minimum of 820 square inches (5.7 square feet) of clear opening
- A maximum of 44 inches from the floor to the sill opening

**For grade floor egress/escape windows installed on or after July 10, 2007:**

- A minimum of 20 inches in width
- A minimum of 24 inches in height
- A minimum of 720 square inches (5.0 square feet) of clear opening
- A maximum of 44 inches from the floor to the sill opening

See the attached diagrams for additional description of acceptable egress windows and a worksheet for determining compliance with the requirements of the MSFC (2007).

**3.3 Special situations**

For unique situations, please see the State Fire Marshal Division policy INS-04 titled, *Escape Windows* for information on how to treat situations that do not fit the conditions outlined here.

**SECTION 4 — WINDOW WELLS**

Escape and rescue windows with a finished sill height below the adjacent ground elevation shall have a window well. Window wells at escape or rescue windows shall comply with MSFC (2007) Section 1026.5. See the attached diagrams for additional description of acceptable egress window wells and a worksheet for determining compliance with the requirements of the MSFC (2007).

**4.1 Window well size**

The window well shall have clear horizontal dimensions that allow the window to be fully opened and provide a minimum accessible net clear opening of 9 square feet with minimum dimensions of 36 inches. Window wells with a vertical depth of more than 44 inches shall be equipped with an approved permanently affixed ladder or stairs that are accessible with the window in the fully open position. The ladder shall not encroach more than 6 inches into the 36-inch clear open space. Please see MSFC (07) Section 1026.5 for additional window well requirements.

**4.2 Obstructions**

Emergency escape or rescue windows, doors or window wells shall be maintained free of any obstruction, including bars, grates or similar devices that would impair egress [MSFC (2007) Section 1028.6]. However, window wells may be covered as necessary to keep the window well clear of debris, snow, and rain water and to help prevent people from falling in if the building owner wishes. However, the cover shall comply with the following requirements:

- a. The covering shall not interfere with the opening of the window in any way.
- b. The covering shall be supported in such a way that it can not become frozen to the ground, window well or structure.
- c. The covering shall be readily removable without the use of tools or special knowledge from the window well area by the building occupants.

**SECTION 5 — STAIRS AND PROTECTION OF OPENINGS**

**5.1 Guardrails – New buildings (constructed after July 10, 2007)**

Unguarded floor openings, open and glazed sides of stairways, landings and ramps and balconies or porches that are more than 30 inches above grade or the floor below shall be protected by guardrails in accordance with the MSFC (2007) Section 1013.1. The top of the guard for a one and two family dwellings may be constructed not less than 36 inches in height. The guards shall have balusters or

ornamental patterns such that a 4-inch diameter sphere cannot pass through any opening up to a height of 34 inches. From 34-36 inches, a sphere 8-inch in diameter shall not pass.

**Guardrails – Existing buildings (constructed before July 10, 2007)**

Guards shall be provided at the open sides of means of egress that are more than 30 inches above the floor or grade below. The guards shall form a protective barrier not less than 36 inches high. For existing guards on the open side of stairs barriers shall be not less than 30 inches high. Open guards shall have balusters or ornamental patterns such that a 6-inch diameter sphere cannot pass through any opening up to a height of 34 inches. Existing open guards may be acceptable if approved by the code official [MSFC (07) Section 1027.6].

**5.2 Stairways – New**

Stairways shall have a handrail on at least one side and the rise and run shall be in accordance with the 2006 International Residential Code (IRC). Stairways shall not be less than 36 inches in clear width at all points above the permitted handrail height and below the required headroom height. The minimum clear width of the stairway at and below the handrail height, including treads and landings, shall not be less than 31.5 inches where a handrail is installed on one side and 27 inches where handrails are provided on both sides. The maximum riser height shall be 7 ¾ inches and the minimum tread depth shall be 10 inches. The riser heights shall be measured vertically between leading edges of the adjacent treads. The tread depth shall be measured horizontally between the vertical planes of the foremost projection of adjacent treads and at a right angle to the tread's leading edge. For additional information on spiral stairs or circular stairways, please review IRC.

**Stairways – Existing**

Existing stairs in buildings shall be permitted to remain if the rise does not exceed 8 ¼ inches and the run is not less than 9 inches. Existing stairs can be rebuilt. Existing stairs may be acceptable if approved by the code official [MSFC (07) Section 1027.10].

**5.3 Handrails – New**

Handrails shall not project more than 4.5 inches on either side of the stairway. Handrails should have a minimum and maximum height of 34 inches and 38 inches, respectively, measured vertically from the nosing of the treads, shall be provided on at least one side of the stairways. All required handrails shall be continuous running the full length of the stairs with two or more risers from a point directly above the top riser of a flight to a point directly above the lowest riser of the flight. Handrails shall not have sharp points at each end and those located adjacent to a walls shall have a space of not less than 1.5 inches between the wall and the handrail.

**Handrails – Existing**

Stairways shall have handrails on at least one side. Handrails shall be located so that all portions of the stairway width required for egress capacity are within 44 inches of a handrail. The height of these handrails measured above stair tread nosings, shall be uniform, not less than 30 inches and not more than 42 inches. [MSFC (2007) Section 1027.13]

**5.4 Storage under stairways – New**

Enclosed usable spaces under stairways must be protected on the enclosed side with at least ½ inch thick gypsum.

**SECTION 6— SPECIAL REQUIREMENTS**

**6.1 Premises identification**

Approved numbers or addresses shall be placed on all new and existing buildings in such a position as to be plainly visible and legible from the street or road fronting the property. The premises

identification numbers shall contrast with their background. In rural areas, the use of fire numbers is acceptable [MSFC (2007) Section 505.1].

### **6.2 Storage of combustible materials**

Storage shall be orderly [MSFC (2007) Section 315.2].

Fueled equipment (motorcycles, lawnmowers, etc.) shall not be stored, operated or repaired within the residence [MSFC (2007) Section 313.1].

### **6.3 Combustible Waste Material**

Combustible waste material creating a fire hazard shall not be allowed to accumulate in buildings [MSFC (07) Section 304.1].

## **SECTION 7 — FIRE RESISTIVE CONSTRUCTION AND INTERIOR FINISH**

### **7.1 Occupancy separation**

When a dwelling has an attached garage, a separation wall between the dwelling and garage is required to prevent the spread of smoke and fire from the garage into the home. The separation must extend from floor to ceiling or roof deck and must be constructed in accordance with the following [IRC Section R309]:

- A single layer of 1/2" gypsum wall board applied on the garage side for both new and existing construction. If there is living space above the garage the ceiling must be protected with minimum 5/8" gypsum wall board.

Door openings must meet one of the following requirements:

- solid-wood door at least 1-3/8 inches in thickness, or
- insulated steel door at least 1-3/8 inches in thickness, or
- a labeled door having a fire-protection rating of not less than 20 minutes.

Doors shall be self-closing and self latching from all positions. Only listed and approved self-closing devices shall be used.

### **7.2 Fire-resistive construction**

Fire-resistive construction, including occupancy separations, area separation walls, exterior walls due to location on property, fire-resistive requirements based on type of construction, draft-stop partitions and roof coverings may be required in some occupancies. When required, they shall be maintained as specified in the MSFC (2007) and MSBC (2007) and shall be properly repaired, restored or replaced when damaged, altered, breached, penetrated, removed or improperly installed [MSFC (2007) Section 703.1]. In general, the only fire-resistive construction in most one and two family dwellings involves the garage separation as described in Section 7.1.

### **7.3 Interior finish**

Interior finish on walls and ceilings shall be Class A, B, or C (Class I, II, or III) [MSFC (2007) Section 803].

## **SECTION 8 — SINGLE AND MULTI-STATION SMOKE ALARMS**

### **8.1 Smoke Alarms within homes constructed prior to July 10, 2007**

Smoke alarms shall be installed in hallways or areas giving access to each separate sleeping area. Where sleeping rooms are on an upper level only, the alarm shall be placed at the center of the ceiling directly above the stairway. Smoke alarms shall also be installed on each level of the dwelling, and within basements having a stairway which opens into the dwelling unit [MSFC (07) Section 907.2.10]. Existing dwelling units not already provided with single or multiple station smoke alarms shall be

provided with approved single or multiple station smoke alarms installed and maintained in accordance with MSFC (07) Section 907.2.10 (Section 8.2 below) meeting requirements for new construction.

For buildings constructed prior to August 1, 1989, alarms may receive their primary power from battery supply. For buildings constructed on or after August 1, 1989, alarms shall be connected to a centralized power source.

### **8.2 Smoke Alarms within homes constructed on or after July 10, 2007**

A smoke alarm shall be installed in each sleeping room and at a point centrally located in the corridor or area giving access to each separate sleeping area. A smoke alarm shall be installed in each story within a dwelling unit, including basements and cellars, but not including crawl spaces and uninhabitable attics. In dwellings or dwelling units with split levels and without an intervening door between the adjacent levels, a smoke alarm installed on the upper level shall suffice for the adjacent lower level provided that the lower level is less than one full story below the upper level [MSFC (2007) Section 907.2.10.1.2].

Smoke alarms shall receive their primary power from the building wiring when such wiring is served from a commercial source and shall be equipped with a battery backup. Wiring shall be permanent and without a disconnecting switch other than those required for over-current protection [MSFC (2007) Section 907.2.10]. When new bedrooms are created, the detector in the new bedroom shall receive its primary power from the building wiring and shall be equipped with a battery backup.

#### **8.2.1 Interconnection in homes constructed on or after July 10, 2007**

Multiple smoke alarms within the same dwelling unit must be interconnected in such a manner that the activation of one alarm will activate all other alarms throughout the dwelling.

### **8.3 Installation**

Detector location and spacing shall be as follows, in addition to the manufacturer's instructions [NFPA 72]:

- a. Smoke detectors in rooms with ceiling slopes greater than 1-foot rise per 8 feet horizontally shall be located at the high side of the room.
- b. A smoke detector installed in a stairwell shall be so located as to ensure that smoke rising in the stairwell cannot be prevented from reaching the detector by an intervening door or obstruction.
- c. A smoke detector installed to detect a fire in the basement shall be located in close proximity to the stairway leading to the floor above.
- d. Smoke detectors shall be mounted on the ceiling at least 4 inches from a wall or on a wall with the top of the detector not less than 4 inches, or more than 12 inches, below the ceiling.
- e. Smoke detectors shall not be located within kitchens, garages, or in other spaces where temperatures can fall below 32 °F, or exceed 100 °F.
- f. Smoke detectors shall not be located within 3 feet of supply registers of a forced air heating or cooling system and doors to a kitchen or bathroom with tub or shower.
- g. For peaked ceilings, the smoke detector must be installed within 3 feet of the peak.

UL or FM (Factory Mutual) listed and approved fire-alarm systems both hardwired and wireless are also acceptable. Detectors with a battery shall emit a signal when the battery is low.

### **8.4 Replacement of Smoke Alarms in One- and Two-Family Dwellings.**

Unless otherwise recommended by the manufacturer, single- and multiple-station smoke alarms installed in one- and two-family dwellings shall be replaced when they fail to respond to operability tests, but shall not remain in service longer than 10 years from the date of manufacture.

## **SECTION 9 — HEATING AND ELECTRICAL EQUIPMENT**

### **9.1 Heating appliances**

Because unvented fuel-fired heating appliances were permitted in residential occupancies by previous editions of the state fire and mechanical codes, existing installations (installed prior to September 20, 2004) are allowed to remain as long as they are in proper working order and are not located in, or take their combustion air from, bedrooms, closets, or bathrooms.

Installations of non-vented fuel fired heaters after September 20, 2004 are prohibited by both the fire and mechanical codes. All fuel-fired heaters must be vented to the exterior.

Furnaces, water heaters, and other heating appliances shall be installed in accordance with their listing and the MSBC (07) and the Mechanical Code [MSFC (2007) Section 603]. All heating appliances installed in garages shall be at least 18 inches above the floor in accordance with the MSFC (07) and the Mechanical Code.

### **9.2 Electrical services**

Electrical hazards shall be corrected according to MSFC (2007) Section 605.1.

Multiplug adapters, such as multiplug extension cords, cube adapters, strip plugs and other devices shall comply with the MSFC (2007) and the Electrical Code [MSFC (2007) Section 605.4].

Receptacles and outlets serviced by extension cord-type wiring are prohibited [MSFC (2007) Section 605.5.1].

Power taps are permitted when polarized or grounded and protected with listed overcurrent protection [MSFC (2007) Section 605.4.1].

Extension cords and flexible cords shall not be used as a substitute for permanent wiring [MSFC (2007) Section 605.5].

## **SECTION 10 – FIRE EXTINGUISHERS**

### **10.1 Fire Extinguishers**

R-3 occupancies used as child daycare shall be provided with fire extinguishers with a minimum 2A:10BC rating.

## **SECTION 11 – SPECIAL PROVISIONS FOR MANUFACTURED (MOBILE) HOMES**

### **11.1 General information**

*This information applies only to manufactured (mobile) homes with fixed running gear.*

Factory built homes that are set on a foundation and do not have fixed running gear shall meet the requirements of the MSFC and MSBC applicable at the time of construction for one and two family dwellings. See the State Fire Marshal Division (SFMD) fact sheet INS-FACT -01 titled, *One and Two Family Dwellings* for these types of buildings that fall under the State Building Code requirements.

Federal standards §3280.105, §3280.106 and §3280.404 cover emergency escapes (second means of egress) for these homes. This section outlines the requirements, although the actual standards should be referenced for full details.

### **11.2 Number and location of exterior exits**

- a. Manufactured homes shall have a minimum of two exterior doors located remote from each other.
- b. Required egress doors shall not be located in rooms where a lockable interior door must be used in order to exit
- c. In order for exit doors to be considered remote from each other, they must comply with all of the following (i. through iv.):
  - i. Both of the required doors must not be in the same room or in a group of rooms which are not defined by fixed walls
  - ii. Single wide units. Doors may not be less than 12 feet center to center from each other as measured in any straight line direction regardless of the length of path of travel between doors.
  - iii. Double wide units. Doors may not be less than 20 feet center to center from each other as measured in any straight line direction regardless of the length of path of travel between doors.
  - iv. One of the required exit doors must be accessible from the doorway of each bedroom without traveling more than 35 feet.
- d. All exterior swinging doors shall provide a minimum 28 inch wide by 74 inch high clear opening. All exterior sliding glass doors shall provide a minimum 28 inch by 72 inch high clear opening.

### **11.3 Escape windows within manufactured (mobile) homes**

Every room designed expressly for sleeping purposes within manufactured (mobile) homes, unless it has an exit door, shall have at least one escape window. The escape window shall comply with section 3.

### **11.4 Access to doors and windows**

Exit doors from individual dwelling units may be provided with a night latch, dead bolt or security chain provided that such devices are openable from the inside without the use of a key or tool and mounted at a height not to exceed 48 inches above the finished floor.

All locking devices shall be of an approved type.

### **11.5 Obstructions**

Emergency escape or rescue windows, doors or window wells shall be maintained free of any obstruction, including bars, grates or similar devices that would impair egress [MSFC (07) Section 1028.6].

## **SECTION 12 – DETECTION SYSTEMS IN MANUFACTURED (MOBILE) HOMES**

At least one smoke detector (which may be a single station alarm device) shall be installed in the manufactured home in the location(s) specified below [MSFC (07) Section 907.2.10].

### **12.1 Housing and Urban Development Code of Federal Regulations (CFR) Revised Smoke Alarm Requirements for Manufactured Homes (Effective September 16, 2002)**

HUD CFR 3280, ‘Manufactured Home Construction and Safety Standards’, are the standards that manufactured homes are constructed to in the United States.

Effective September 16, 2002, the Department of Housing and Urban Development (HUD) revised their smoke detector requirements within manufactured homes. When a mobile home is installed in a municipality’s jurisdiction and show a date of manufacture of 9/16/02 or newer on the data plate the



home must comply with the amended smoke alarm requirements. Data plates are required on all HUD homes as per CFR 3280.5 and must indicate the date of manufacture on the data plate.

### **12.1.1 New manufactured (mobile) homes**

The changes to the HUD smoke alarm rules are as follows:

- Section 3280.208 (b)(1)(i), requires at least one smoke alarm to protect the living and kitchen areas, whether the areas are separate or combined. If a smoke alarm is installed within 20 feet of a cooking appliance, the rule requires either the smoke alarm include a temporary silencing feature (hush button) or that the smoke alarm be of a photo-electric type. Whenever possible, the alarm should be located in the living area remote from the kitchen and cooking appliance
- Section 3280.208 (b)(1)(ii), manufacturers are to install a smoke alarm in each room “designed for sleeping”.
- Section 3280.208 (b)(1)(iii), permits, exclusive of basements, the required stairway smoke alarms in multistory homes to be installed on the ceiling near the top of the stairway, or above the stairway, for field installation and interconnection of the required smoke alarms.
- Section 3280.208 (b)(2), requires each manufacturer to provide, but not necessarily to install, a smoke alarm for every home designed to be placed over a basement. The manufacturer must install an electrical junction box that accommodates the installation and interconnection of the basement smoke alarm. The instructions and information provided by the manufacturer for the installer and homeowner must make it clear that the smoke alarm is to be installed on the basement ceiling near the stairway.
- Section 3280.208 (c)(1,2,3), permits manufacturers to mount smoke alarms on ceilings, except in rooms with peaked sloping or shed sloping ceilings of more than 1.5/12, smoke alarms must be mounted on the ceiling within 3 feet, measured horizontally, of the high side of the ceiling, and not closer than 4 inches from any adjoining wall surface and from any projecting structural element.
- Section 3280.208 (d)(1)(i&ii), requires each smoke alarm to be powered by the home’s electrical system and be provided with a battery back-up, or, alternatively, to be powered by a battery with a 10-year life.
- Section 3280.208 (d)(2), clarifies that more than one smoke alarm may be placed on the same electrical circuit.
- Section 3280.208 (d)(3), requires that mandated smoke alarms be interconnected so that operation of any one alarm activates all other required alarms in the manufactured home.

### **12.1.2 Smoke detector location (Mobile homes constructed prior to September 16, 2002)**

- a. A smoke detector shall be installed on any wall in the hallway or space communicating with each bedroom area between the living area and the first bedroom door unless a door(s) separates the living area from that bedroom area, in which case the detector(s) shall be installed on the living area side as close to the door(s) as practicable. Homes having bedroom areas separated by any one or combination of the common-use areas such as kitchen, dining room, living room, or family room (but not a bathroom or utility room) shall have at least one detector protecting each bedroom area.
- b. When located in hallways, the detector shall be between the return air intake and the living area.
- c. A smoke detector shall not be placed in a location that impairs its effectiveness.
- d. Smoke detectors shall be listed and approved for their use and location.

### **12.1.3 Power supply**

The required detector(s) shall be attached to an electrical box and the detector connected by a permanent wiring method into a general electrical circuit. There shall be no switches in the circuit to the detector between the over current protection device protecting the branch circuit and the detector. Smoke detector(s) shall not be placed on the same branch circuit or any circuit protected by a ground fault circuit interrupter.

### **12.1.4 Installation**

Each smoke detector shall be installed in accordance with its listing. The top of the detector shall be located on a wall 4 inches to 12 inches, or a distance permitted by the listing, below the ceiling. However, when a detector is mounted on an interior wall below a sloping ceiling, it shall be located 4 inches to 12 inches below the intersection of the connecting exterior wall and the sloping ceiling (cathedral ceiling). When basements are installed under these homes, the basement shall meet the applicable requirements of the MSFC (07) and MSBC (07) based on the date of construction. When manufactured (mobile) homes are set on basements (running gear removed or remaining), the manufactured (mobile) home shall have exiting (doors, windows etc.) installed according to the Federal ANSI or HUD standard under which it was built.

## **SECTION 13 – EMERGENCY EVACUATION PLANNING FOR PEOPLE WITH DISABILITIES**

### **13.1 Emergency evacuation for people with disabilities**

The National Fire Protection Association (NFPA) has developed a guide for emergency evacuation and planning for people with disabilities. Although this is not a requirement within the MSFC, this document contains helpful information for homeowners on how to address this complicated evacuation issue. It provides information on the five general categories of disabilities: mobility impairments, visual impairments, hearing impairments, speech impairments, and cognitive impairments. It also outlines the four elements of evacuation information that occupants need: notification, way of finding the exits, use of the exit way, and assistance. The Guide features a checklist that building services managers and people with disabilities can use to design a personalized evacuation plan. The annexes give government resources and text based on the relevant code requirements and ADA criteria.

This document can be viewed by following the attached link to the NFPA web site:  
<http://www.nfpa.org/categoryList.asp?categoryID=824&cookie%5Ftest=1>.

# Escape Window Worksheet for Windows Installed Before July 10, 2007

## 1) CHECK WINDOW HEIGHT AND WIDTH

DOUBLE HUNG

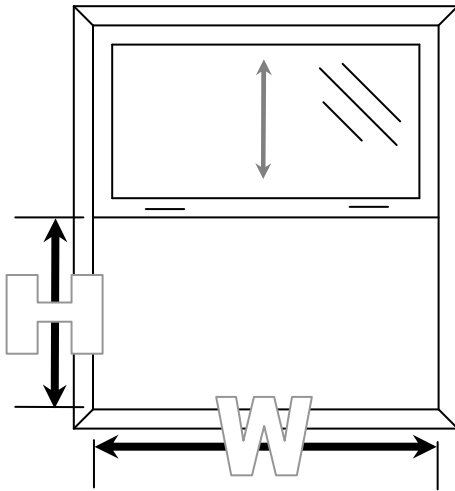

SLIDING

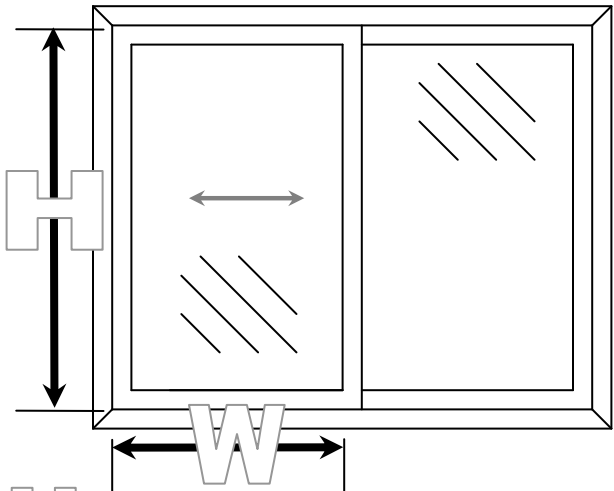

CASEMENT

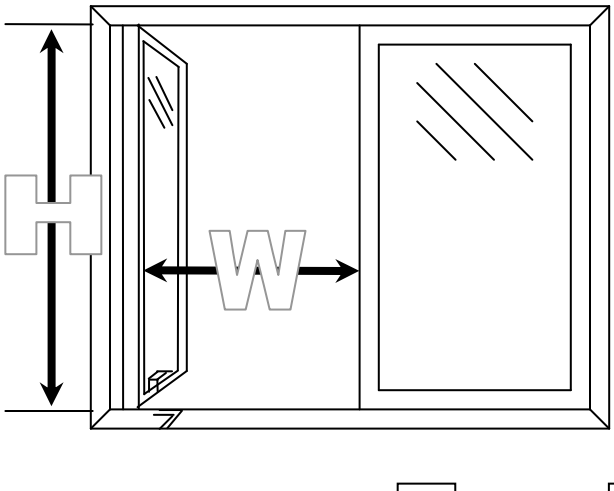

Is the clear openable height, **H** at least 20 inches?      Yes       No

Is the clear openable width, **W** at least 20 inches?      Yes       No

## 2) Check Window Opening Area (fill in the three blanks)

**H** \_\_\_\_\_ **X** **W** \_\_\_\_\_ = **A** \_\_\_\_\_

Openable height (inches)      Openable width (inches)      Openable area (square inches)

Is the clear openable area, **A** at least 648 square inches?      Yes       No

## 3) Check the distance from the floor to the bottom of opening

Is the distance, **S** from the floor to the finished sill (bottom of opening) 48 inches or less?      Yes       No

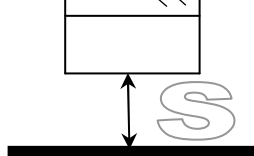

If you answered yes to all questions then the window should comply with the 2007 Minnesota State Fire Code. For assistance: Minnesota State Fire Marshal Division (651) 201-7200; TTY: (651) 282-6555; firecode@state.mn.us

# Escape Window Worksheet for Ground Floor Windows Installed On or After July 10, 2007

## 1) CHECK WINDOW HEIGHT AND WIDTH

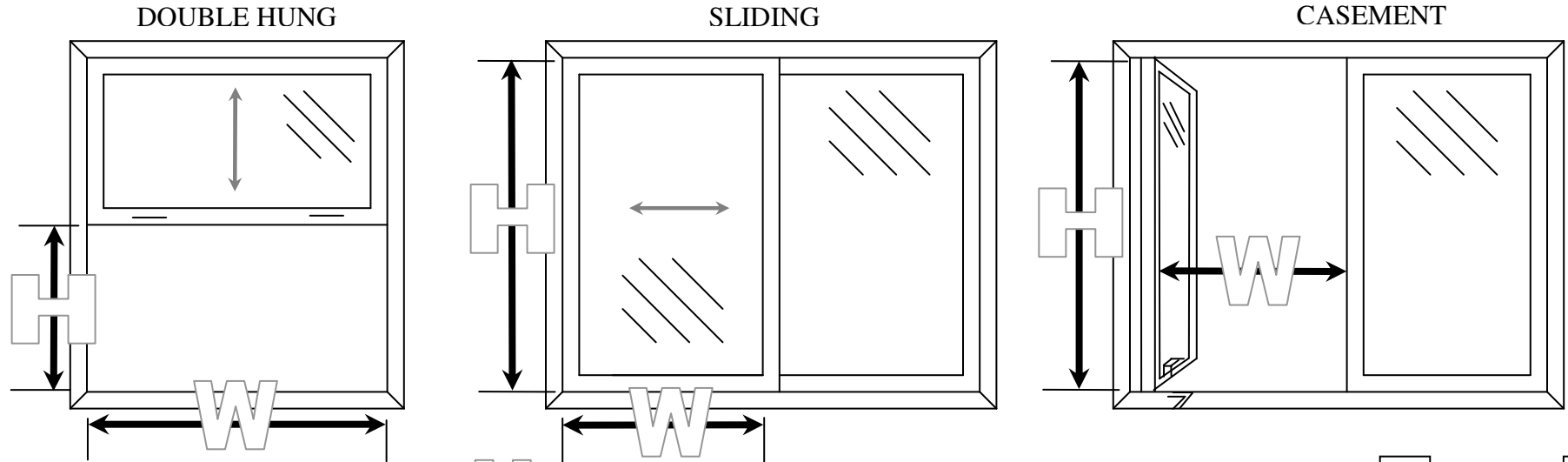

Is the clear openable height,

**H** at least 24 inches?

Yes  No

Is the clear openable width,

**W** at least 20 inches?

Yes  No

## 2) Check Window Opening Area (fill in the three blanks)

**H** \_\_\_\_\_ **X** **W** \_\_\_\_\_ = **A** \_\_\_\_\_  
 Openable height (inches)      Openable width (inches)      Openable area (square inches)

Is the clear openable area, **A** at least 720 square inches?

Yes  No

## 3) Check the distance from the floor to the bottom of opening

Is the distance, **S** from the floor to the finished sill  
 (bottom of opening) 44 inches or less?

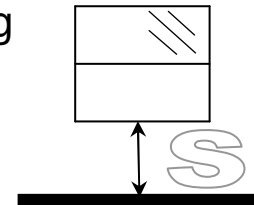

Yes  No

If you answered yes to all questions then the window should comply with the 2007 Minnesota State Fire Code.  
 For assistance: Minnesota State Fire Marshal Division (651) 201-7200; TTY: (651) 282-6555; firecode@state.mn.us

# For Escape Windows Installed Above or Below the Level of Exit Discharge on or after July 10, 2007

## 1) CHECK WINDOW HEIGHT AND WIDTH

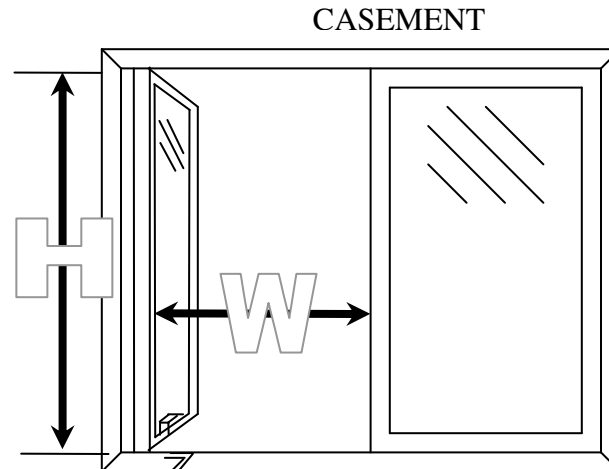
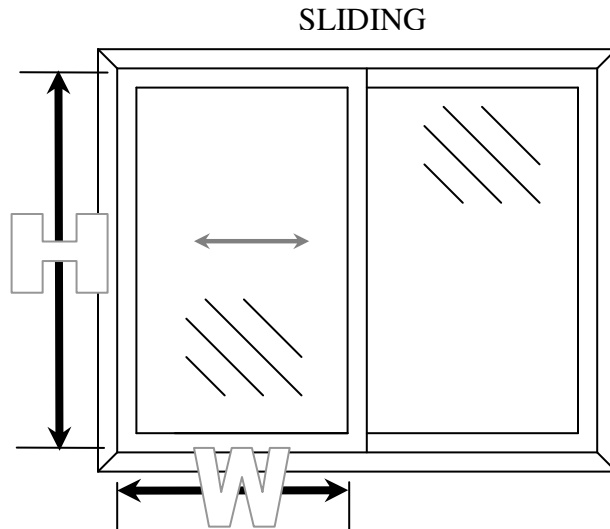
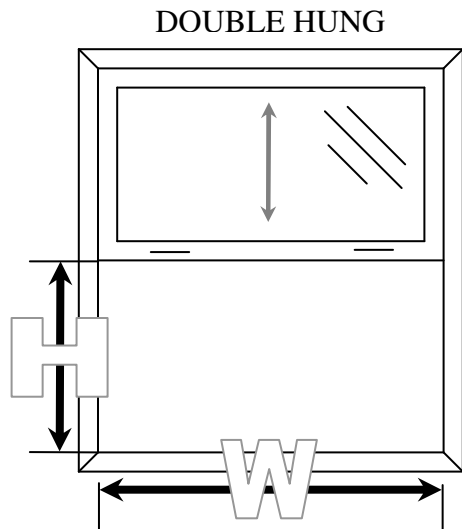

Is the clear openable height,

**H** at least 24 inches?

Yes  **No**

Is the clear openable width,

**W** at least 20 inches?

Yes  **No**

## 2) Check Window Opening Area (fill in the three blanks)

**H** \_\_\_\_\_

Openable height (inches)

**X**

**W** \_\_\_\_\_

Openable width (inches)

=

**A** \_\_\_\_\_

Openable area (square inches)

Is the clear openable area,

**A** at least 820 square inches?

Yes  **No**

## 3) Check the distance from the floor to the bottom of opening

Is the distance,

**S**

from the floor to the finished sill

(bottom of opening) 44 inches or less?

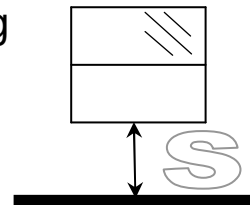

Yes  **No**

If you answered yes to all questions then the window should comply with the 2007 Minnesota State Fire Code.  
 For assistance: Minnesota State Fire Marshal Division (651) 201-7200; TTY: (651) 282-6555; firecode@state.mn.us

# Window Well Worksheet When Installed On or After June 29, 1998

## 1) CHECK WINDOW WELL DIMENSIONS

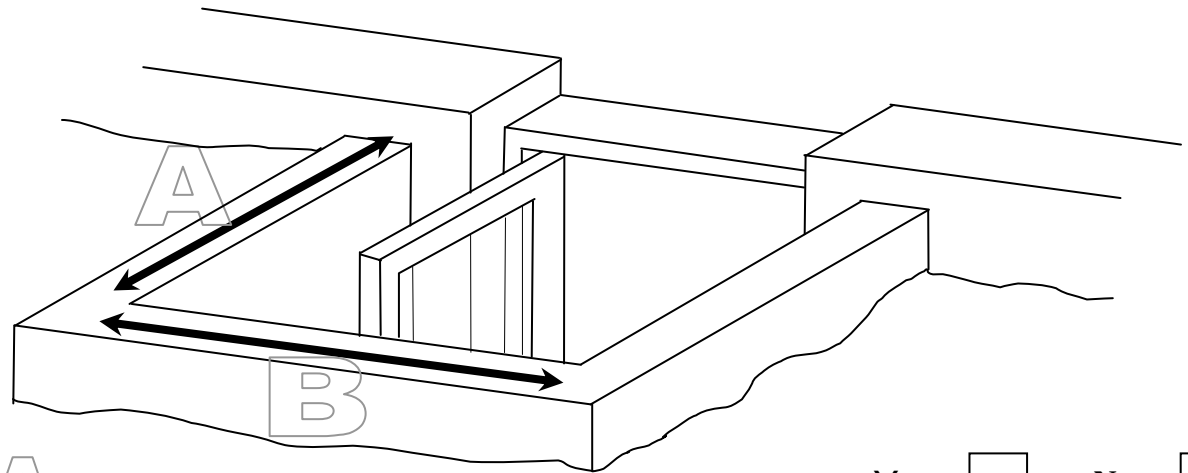

Is the clear horizontal distance,

**A** at least 36 inches?

Yes  No

Is the clear horizontal distance,

**B** at least 36 inches?

Yes  No

## 2) Check Window Well Opening Area (fill in the three blanks)

$$A \text{ \_\_\_\_\_\_ } \times B \text{ \_\_\_\_\_\_ } = \text{Area } \text{ \_\_\_\_\_\_ }$$

Horizontal distance (inches)

Horizontal distance (inches)

Net horizontal opening (square inches)

Is the **Area** at least 1,296 square inches?

Yes  No

## 3) Check the vertical depth of the window well

If the distance, **D** from the bottom of the well to the top at grade is more than 44 inches, a ladder is required.  
If a ladder is required, is one provided?

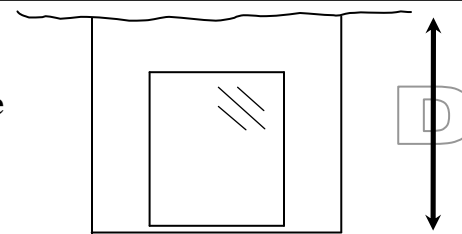

Yes  No

If you answered yes to all questions then the window should comply with the 2007 Minnesota State Fire Code  
For assistance: Minnesota State Fire Marshal Division (651) 201-7200; TTY: (651) 282-6555; firecode@state.mn.us